

KENWOOD

CD RECEIVER

KDC-7001

KDC-6001

KDC-5001

INSTRUCTION MANUAL

KENWOOD CORPORATION



Take the time to read through this instruction manual. Familiarity with installation and operation procedures will help you obtain the best performance from your new CD receiver.

For your records

Record the serial number, found on the back of the unit, in the spaces designated on the warranty card, and in the space provided below. Refer to the model and serial numbers whenever you call upon your KENWOOD dealer for information or service on the product.

Model KDC-7001/6001/5001 Serial number

Contents

Before use

Warning	3
Safety precautions	4
Care and Maintenance	5
Handling compact discs	6
Features	7

Basic operations

Power/Volume/Attenuator	9
Loudness	10
Auto seek tuning	11
Manual tuning	12
Local seek	13
Compact disc play	14
Basic operations of remote control	15

Tuner features

Station preset memory	17
Auto memory entry	18
Priority radio preset	19
CRSC	20
Direct access tuning	21
Channel spacing selection	22

CD player features

Track search	23
Direct track search	24
Track repeat	25
Track scan	26
Random play	27

Other features

Audio controls	28
Selectable illumination/display type	30
Clock display/setting	31
Theft deterrent faceplate	32
Disabled system indicator	33

Installation

Accessories	34
Installation procedure	35
Connections(KDC-7001/6001)	36
(KDC-5001)	37
Installation	38

Troubleshooting guide	40
-----------------------------	----

Specifications	41
----------------------	----

Warning

▲CAUTION

The use of optical instruments with this product will increase eye hazard.

INFORMATION

This equipment generates and uses radio frequency energy and if not installed and used properly, that is, in strict accordance with the manufacturer's instructions, may cause interference to radio and television reception. It has been type tested and found to comply with the limits for a Class B computing device in accordance with the specifications in Subpart J of Part 15 of FCC Rules, which are designed to provide reasonable protection against such interference in a residential installation.

However, there is no guarantee that interference will not occur in a particular installation. If this equipment does cause interference to radio or television reception, which can be determined by turning the equipment off and on, the user is encouraged to try to correct the interference by one or more of the following measures:

- Reorient the receiving antenna
- Relocate this equipment with respect to the receiver
- Move this equipment away from the receiver
- Plug this equipment into a different outlet so that equipment and receiver are on different branch circuits.

If necessary, the user should consult the dealer or an experienced radio/television technician for additional suggestions. The user may find the following booklet prepared by the Federal Communications Commission helpful:

"How to Identify and Resolve Radio-TV Interference Problems".

This booklet is available from the U.S. Government Printing Office, Washington, DC 20402, Stock No. 004-000-00345-4.

- AS the laser beam used in this compact disc player is harmful to the eyes, do not attempt to disassemble the cabinet. Refer servicing to qualified personnel only.

FCC WARNING

This equipment may generate or use radio frequency energy. Changes or modifications to this equipment may cause harmful interference unless the modifications are expressly approved in the instruction manual. The user could lose the authority to operate this equipment if an unauthorized change or modification is made.

NOTE

This equipment has been tested and found to comply with the limits for a Class B digital device, pursuant to Part 15 of the FCC Rules. These limits are designed to provide reasonable protection against harmful interference in a residential installation. This equipment may cause harmful interference to radio communications, if it is not installed and used in accordance with the instructions. However, there is no guarantee that interference will not occur in a particular installation. If this equipment does cause harmful interference to radio or television reception, which can be determined by turning the equipment off and on, the user is encouraged to try to correct the interference by one or more of the following measures:

- Reorient or relocate the receiving antenna.
- Increase the separation between the equipment and receiver.
- Connect the equipment into an outlet on a circuit different from that to which the receiver is connected.
- Consult the dealer or an experienced radio/TV technician for help.

Safety precautions

Before use

▲WARNING

Take the following precautions to prevent fire and avoid personal injury :

- Press in the faceplate until it is firmly locked to the main unit to prevent it from being detached in an accident.
- When extending the power supply cable, memory backup cable, or ground cable, use 0.75mm² (AWG18) or larger automotive grade cable to avoid cable deterioration or damage to the covering.
- Check that no metal objects (coins, tools, etc.) are left inside the unit to avoid short circuits.
- If you smell or see smoke, turn the power off immediately and consult your Kenwood dealer.

▲CAUTION

Take the following precautions to keep the unit in proper working order.

- Be sure the unit is connected to a 12V DC power supply with a negative ground connection.
- Do not open the top or bottom cover.
- Do not install the unit in places it is exposed to direct sunlight, high heat or humidity, water may splash over it, or dust exists.
- Do not store the detached faceplate or faceplate storage case in places it is exposed to direct sunlight or high heat.
- Do not splash water on the faceplate.
- The faceplate is a precision piece of equipment that contains sensitive parts. Do not subject it to excessive shock.

- If you need to replace the fuse, make sure the new fuse is of the same type and rating. Using a fuse of a different type of rating may damage your unit. The fuse rating is normally shown on the fuse and fuse box.

NOTE

- If you have difficulty in installing this unit in your vehicle, contact your Kenwood dealer.
- If it doesn't seem to be working properly, first press the Reset button. If the malfunction persists, consult your Kenwood dealer.



Reset button

Care and Maintenance

Cleaning the unit

- If the front panel is dirty, wipe it clean with a silicon cloth or soft dry cloth with the power off.

▲CAUTION

Do not use hard cloths or paint thinner, alcohol, or other volatile solvents. These may damage external surfaces or remove indicator characters.

Cleaning the CD slot

- Since dust accumulates in the CD slot, it will sometimes need to be cleaned. Discs loaded in dusty slots may be damaged.

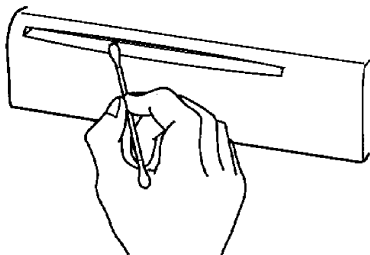

Lens fogging

- In cold climates, there may be a period after you turn on your vehicle's heater when the lens that guides the laser beam used in your CD player fogs up. If this happens, you cannot play compact discs. Take out discs and the fogging will disappear. If it does not return to normal after several hours, contact your Kenwood dealer.

Heat protection

- In warm climates, when vehicles are left standing in direct sunlight with the windows closed, the temperature inside can rise above 60°C. The unit's protection circuits will then display the message "HOLd" and prevent the player from operating. Just open the windows or turn on the air conditioning. As soon as the "HOLd" message disappears, the player will operate normally.

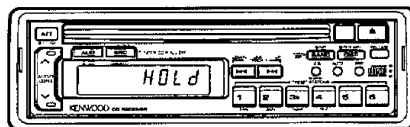

- The temperature inside the unit rises when you use the unit with the high volume level. If this occurs while you are listening to CD, the unit stops CD play to protect the laser pick-up, and the display shows "H-HOLD". The protection circuits are automatically canceled in about 15 minutes, and the CD play will be resumed reducing 10 dB of the previously set volume level.

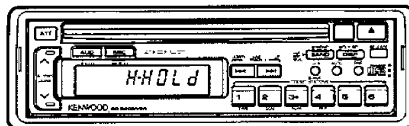

Handling compact discs

Before use

Stains, scratches, or warping can cause skipping, malfunction, or low sound quality. Take the following precautions to avoid damage to the compact discs.

Holding a disc

- Avoid touching the recorded side (the side without the titles on) when you hold a compact disc.

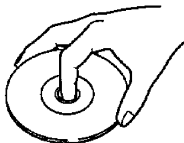

- Do not stick paper tape, etc. on either stick of the disc.

Paper tape



Storing your discs

- Do not store discs where they will be exposed to direct sunlight (such as on the seat and dashboard) or high heat.
- If you do not use your unit for an extended time, remove the discs from the unit and put them in their cases. Do not leave them lying around without cases, piled up, or leaning on a wall and so on.

Cleaning your discs

- If there are stains on a disc, wipe them off with a cleaning cloth or a soft cotton cloth, wiping from the center to the edge. Never use conventional record cleaners, anti static agent, paint thinner, benzene, or other chemicals.

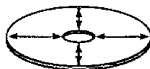

Check your new discs

- Some new discs have burrs on their outer edges or around the hole in the center. Discs with burrs may not fit properly on the player, causing skipping when they are played. Use a ballpoint pen or similar instrument to remove the burrs.

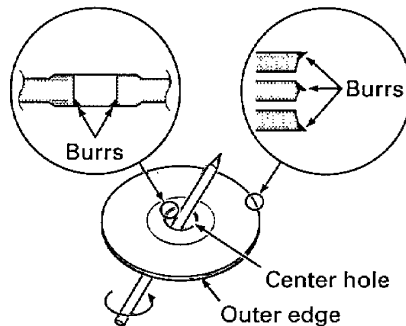

Disc accessories

- Stabilizers, protective seals, and other disc accessories on the market, which claim to offer improved sound quality or disc protection, may cause this unit to malfunction. They should not be used on discs played in this unit.

CAUTION

Never use 8 cm (3") compact discs

- If you attach an adapter to an 8 cm (3") compact disc and load it into this unit, the adapter may be detached from the disc, causing damage to the unit. Do not use 8 cm (3") compact discs.

Features

■ Tuner section

- **Auto seek tuning (Page 11)**
Automatically searches for stations you can receive.
- **Stations preset memory (Page 17)**
Stores the frequencies of your favorite stations in memory. The frequencies stored in memory can be recalled by a single touch of a button.
- **Auto memory entry (Page 18)**
Automatically stores the stations in the band you are listening to in memory. You can tune to the stations stored in memory by a single touch of a button in the same way as for the Stations preset memory function. If you use this function when you drive a long way and do not know what stations are available there, you can check the programmes broadcast by local stations by recalling them by a single touch of a button.
- **Priority radio preset (Page 19)**
This function enables you to tune to the preset station by a single touch of a button while you are listening to a disc. Since you can listen to a station without switching to the tuner mode, it is useful to listen your favorite station (such as news, traffic information).
- **Direct access tuning (Page 21) (Function of the KDC-7001)**
This feature allows you to listen to the station of your choice immediately by inputting its frequency.
(Remote control function)
- **Local seek (Page 13)**
When this feature is turned on, the tuner scans only the stations offering good reception during Auto seek tuning and Auto memory entry.
- **CRSC (Clear Reception System Circuit) (Page 20)**
When this feature is turned on, the tuner switches reception to mono to reduce multi-path noise if it occurs in the broadcast you are listening to.
- **Channel space selection (Page 22)**
This feature allows you to change the frequency step between 200 kHz in FM/10 kHz in AM and 50 kHz in FM/9 kHz in AM.

Features

Before use

■ CD player section

- **Direct track search (Page 24)**
(Function of the KDC-7001)
This feature allows you to enter the number of the track you wish to hear by pressing the appropriate numeric keys. (Remote control function)
- **Track repeat (Page 25)**
When this function is turned on, the track you are listening to is played repeatedly.
- **Track scan (Page 26)**
When this function is turned on, the first part of each track on the disc you are listening to is played automatically to help you find the one you want.
- **Random play (Page 27)**
When this function is turned on, the tracks on the disc you are listening to are played in random order.

■ General section

- **Remote control (Page 15)**
(Function of the KDC-7001)
This unit can be operated with the wireless remote control.
There are also convenient features available only with the remote control.
- **Attenuator (Page 9)**
This function allows you to lower the volume quickly. The fade-in function is provided to restore the original volume gradually.
- **Loudness control (Page 10)**
When this function is turned on when the volume level is low, sound is made clear by emphasizing bass.
- **Audio controls (Page 28)**
Adjust the bass, treble, balance, and fader.
- **Selectable illumination (Page 30)**
Allows illumination colour to be switched between green and orange.
- **Selectable display type (Page 30)**
(Function of the KDC-7001/6001)
Allows the display type to change between negative and positive.
- **Clock display (Page 31)**
The time can be displayed.
- **Theft deterrent faceplate (Page 32)**
The faceplate is detachable. When you leave the vehicle, you can take the faceplate with you to help prevent theft.
- **Disabled system indicator (Page 33)**
When the faceplate is detached from the unit, the LED blinks.

Power/Volume/Attenuator

Attenuator

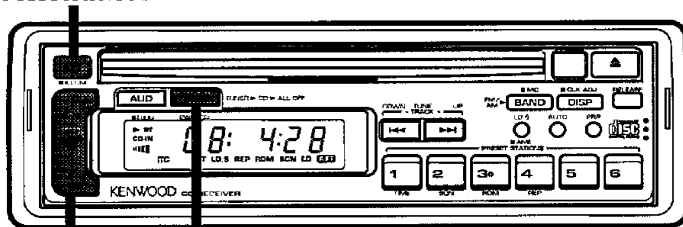

Volume Power

Basic operations

To turn the power on

Press the Source button.

NOTE

Perform the following operations with the power on.

To turn the power off

Press the Source button for more than a second.

To use the Attenuator function

Press the Attenuator button. The Attenuator indicator will appear on the display and Attenuator function will turn on.

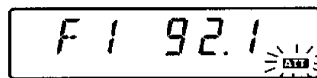

ON

To cancel the Attenuator function

Press the Attenuator button or set the volume to minimum. The Attenuator indicator disappears and the Attenuator function is cancelled.

To increase the volume

Press the Audio up button.

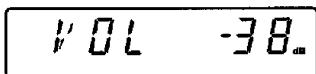

To decrease the volume

Press the Audio down button.

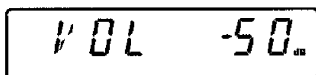

Loudness

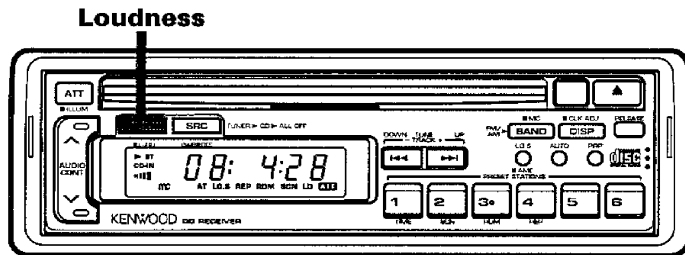

To use loudness control

Press the Loudness button for more than a second. Loudness is turned on and the Loudness indicator appears on the display. This function is factory-set to ON.

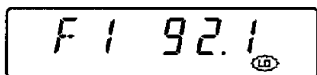

ON

To cancel loudness control

Press the Loudness button for more than a second. Loudness is turned off and the Loudness indicator disappears.

Auto seek tuning

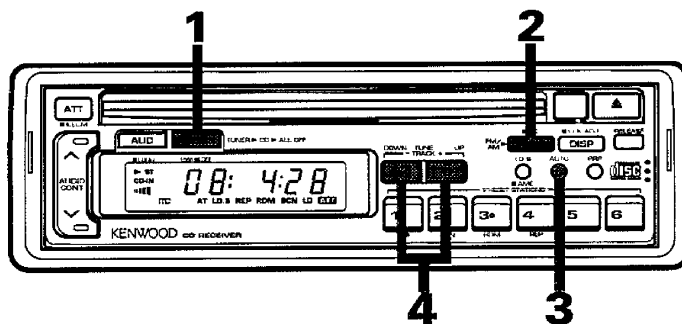

- 1** Listen to the radio
Press the Source button to select Tuner mode.
When "TUNER" is displayed, you are in Tuner mode.

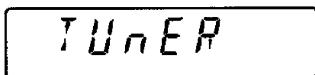

- 3** To select Auto seek tuning mode
Press the Auto button.
The Auto indicator will appear on the display and Auto seek tuning will turn on. This function is factory-set to ON.

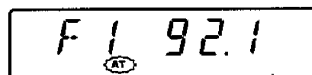

- 2** To select a band
Press the Band button.
Each time you press the button, the band changes between FM1, FM2, FM3, and AM.

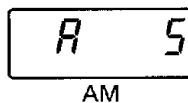
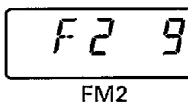
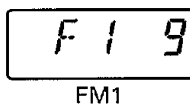

- 4** To tune
Press the Tuning up/down button.
When the Tuning up button is pressed, up seeking is performed.
When the Tuning down button is pressed, down seeking is performed.
The Stereo indicator appears on the display when stereo broadcasts are received.

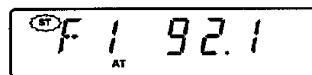

Manual tuning

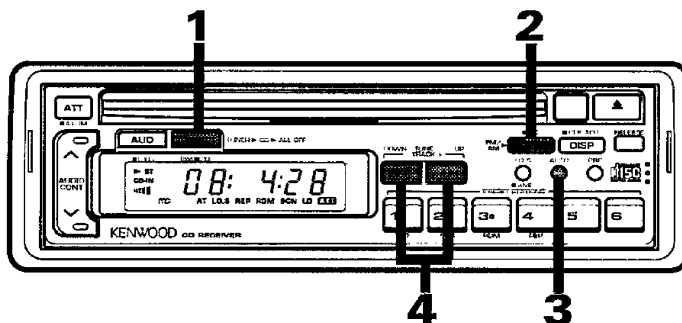

- 1** Listen to the radio
Press the Source button to select Tuner mode.
When "TUner" is displayed, you are in Tuner mode.

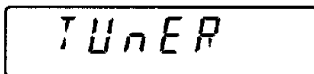

- 3** To select Manual tuning mode
Press the Auto button.
The Auto indicator disappears and the Auto seek tuning is cancelled.

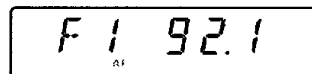

- 2** To select a band
Press the Band button.
Each time you press the button, the band changes between FM1, FM2, FM3, and AM.

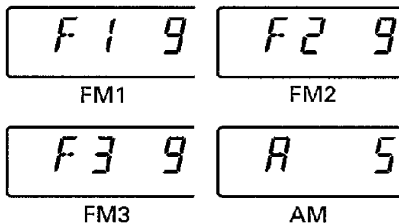

- 4** To tune
Press the Tuning up/down button.
When you press the button once, the received frequency changes by one step. The frequency will continue to change as long as you hold the button down.
The Stereo indicator appears on the display when stereo broadcasts are received.

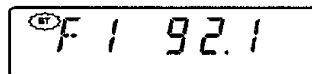

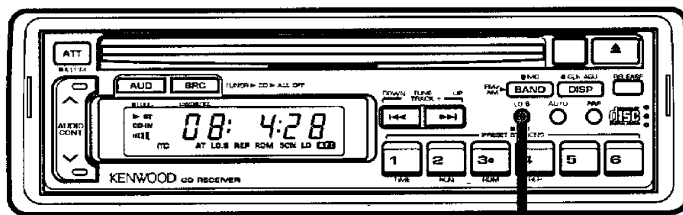

Local seek

To use Local seek

Briefly press the Local seek button. The Local seek indicator will appear on the display, and local seek will turn on.

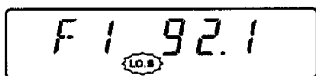

ON

To cancel Local seek

Briefly press the Local seek button. The Local seek indicator disappears, and local seek turns off.

Compact disc play

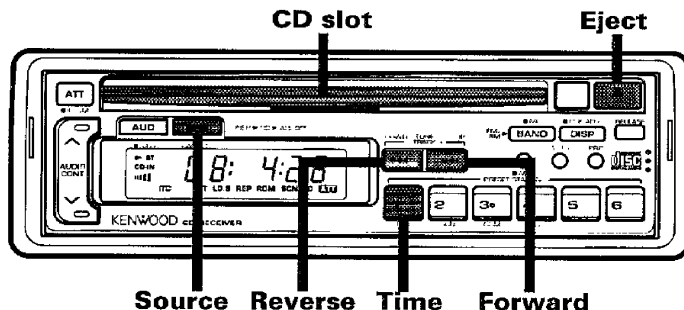

To play compact discs

Insert a CD with the title side up.
CD playing will start.

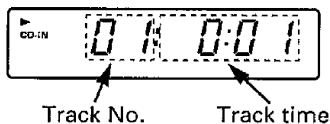

If there is already a CD in the unit,
press the Source button to select
CD mode.

When you enter CD mode, "Cd" will
be displayed, and CD playing will
start.

CAUTION

- Do not attempt to insert a disc in a slot where there is already another disc inside.
This unit is designed for playing 12 cm (5") compact discs. Attempting to play 8 cm (3") disc may damage the unit and should be avoided.
- If you eject a CD shortly after it has been loaded and try to push it in again, the CD may not be reloaded. In this case, take the CD right out and reinsert it.

To stop and eject

Press the Eject button.
CD play stops and the disc is ejected.

To fast forward

Hold down the Forward button.
When you release the button, CD
play restarts.

To reverse

Hold down the Reverse button.
When you release the button, CD
play restarts.

To switch play time display type

Press the Time button.
Each time you press the button, the
track time and the total CD play time
are displayed alternately.

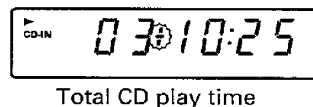
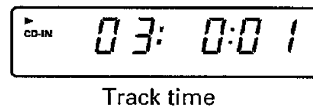

Basic operations of remote control

Function of the KDC-7001

All modes

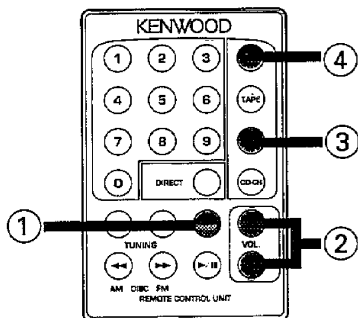

① Attenuator button

Lowers volume immediately.
To restore previous level, press this button again or set the volume to minimum.

② Volume button

The \wedge button increases the volume.
The \vee button decreases the volume.

③ CD button

Each press of this button switches between the CD mode and the tuner mode.

④ Tuner button

Each press of this button switches between the tuner mode and the standby mode.

Replacing the battery

- Use one lithium battery (CR2025).
- Insert the battery according to the illustration inside the battery case, taking care not to reverse the + and - polarity.
- If no operation occurs even when a button is pressed, the battery may be exhausted. Replace with a new battery.

▲WARNING

- Store the lithium battery outside the reach of children. In case a person swallows a lithium battery, immediately call the doctor.

NOTE

- Before using the remote controller for the first time, pull out the film from the battery case.

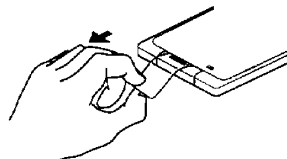

Basic operations of remote control

Function of the KDC-7001

Tuner mode

Basic operations

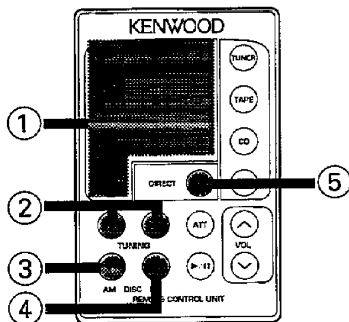

① Numeric keys

Numeric keys 1 to 6 are used to recall preset stations.
Enter the frequency of the station during Direct access tuning (Page 21).

② Tuning button

The ◀◀ button decreases the frequency.
The ▶▶ button increases the frequency.

③ AM button

Press the AM button to choose AM mode.

④ FM button

Each time you briefly press the FM button, the band changes between FM1, FM2, and FM3.

⑤ Direct button

Press the Direct button to select Direct access tuning mode.

CD mode

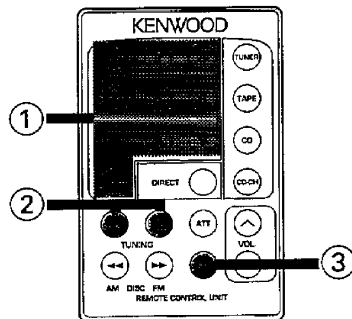

① Numeric keys

Use numeric keys to specify the track number during direct track search (Page 24).

② Track search button

Press the ◀◀ button to find a previous track.
Press the ▶▶ button to find a subsequent track.

③ ▶/|| button

Plays/pauses CD play.

Station preset memory

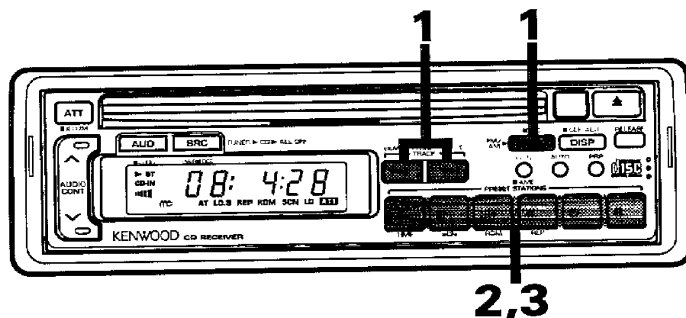

1 Select the band and station (frequency) you want to preset.

2 To preset
Press the Preset station button (1 to 6) you want to use for more than two seconds.
When the station is entered in memory, the number of the button to which you've assigned it will be displayed.

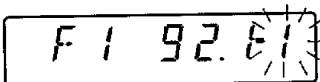

You can preset each button for one station each from the FM1, FM2, FM3, and AM bands.

NOTE

To change preset frequencies
Tune in a station you want to preset and press the Preset station button you want to change for more than two seconds.

3 To recall a preset station
Briefly press the Preset station button (1 to 6) you want.
The number of the button that you pressed will be displayed, and the preset station will be recalled.

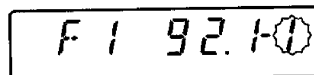

Auto memory entry

Tuner features

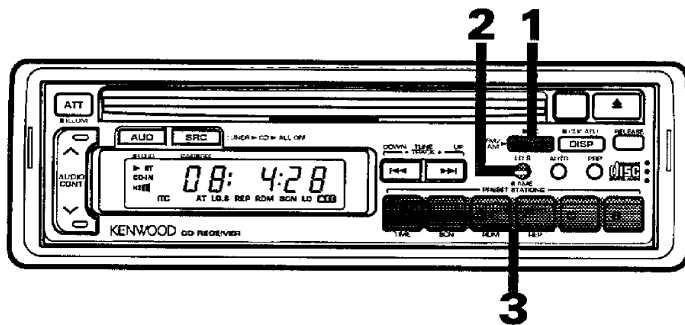

- 1** Select the band for Auto memory entry.

- 2** Auto memory entry
Press the Auto memory button for more than two seconds. Auto memory entry starts and preset station button numbers are displayed in order.

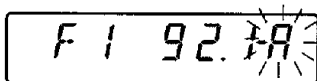

When stations are preset in all Preset stations buttons, or all the stations that can be received in the selected band are preset, Auto memory entry ends. The last preset station is received.

- 3** To recall stations stored in memory by Auto memory entry Briefly press a Preset station button (1 to 6). The number of the pressed button is displayed, and the station is recalled.

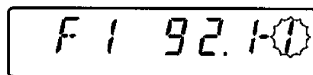

Priority radio preset

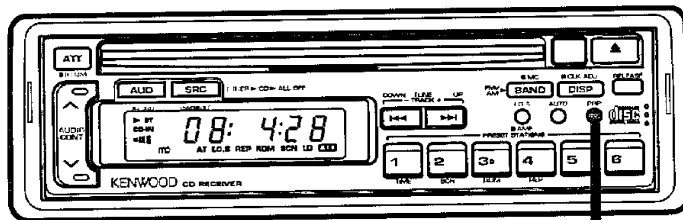

Priority radio preset

To recall preset stations

Press the Priority radio preset button.

The Priority radio preset indicator appears on the display and the preset station is recalled.

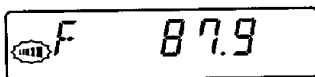

ON

To return to the original mode

Press the Priority radio preset button.

The Priority radio preset indicator disappears and the original mode returns.

To change the station to be recalled

Tune to the station you want in the Priority radio preset mode.

Only Auto seek tuning and Manual tuning can be performed in the Priority radio preset mode. Tune to the desired station by Auto seek tuning or Manual tuning.

The station you are tuned to is automatically preset, and will be recalled subsequently.

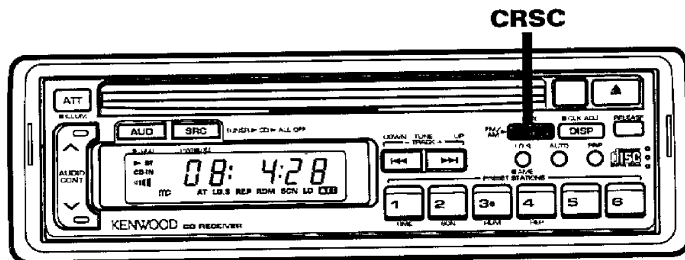

Tuner features

To turn CRSC on

Press the MC button for more than a second. The mc indicator disappears on the display and the CRSC function will turn on. This function is factory-set to ON.

NOTE

If FM sound is unstable: With CRSC function on, strong electrical field (from power lines, for instance) may make the sound level fluctuate. If this happens, try turning CRSC off.

To cancel the CRSC

Press the MC button for more than a second. The mc indicator will appear on the display and the CRSC function is cancelled.

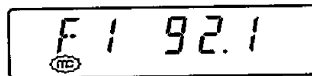

OFF

Direct access tuning

Function of the KDC-7001

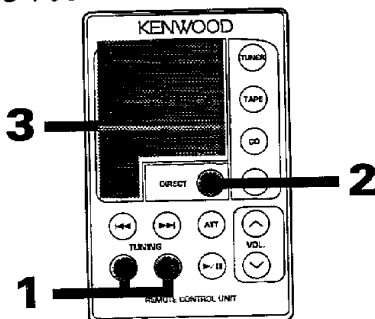

1

Select the band you want.

2

Press the Direct button.
The frequency display blinks for 10 seconds.

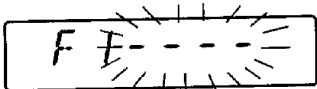

3

Enter the frequency you want while the frequency display is blinking.

For example:

- To tune to 92.1 MHz FM;
Press 9, 2, and 1.
- To tune to 530 kHz AM;
Press 5, 3, and 0.

NOTE

The tuner receives the frequency you entered.
You cannot enter frequencies your tuner cannot receive in each band.

To cancel

To cancel in the middle, press the Direct button.
The Direct access tuning function is cancelled and the frequency display stops blinking.

Channel space selection

Tuner features

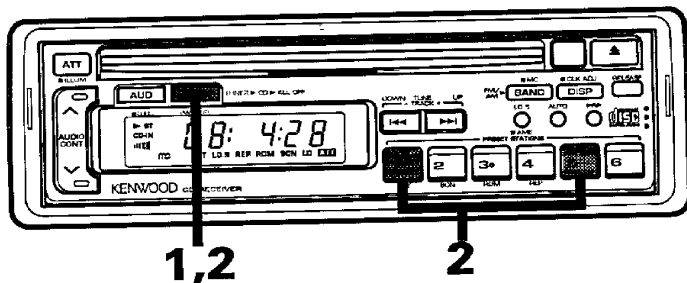

1

Turn the power off.

2

Hold down preset station buttons "1" and "5" and turn the power on. The frequency step is 50 kHz in FM and 9 kHz in AM.

NOTE

- When the frequency step is changed, all the contents of memory become the initial values.
- This function is not available in the United States and Canada.

To return to the original frequency step

Perform steps 1 and 2 again. The frequency step returns to its original value.

Track search

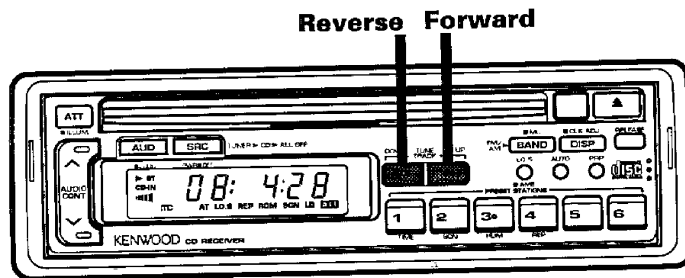

Reverse track search

Briefly press the Reverse button. When you press this button once, the player returns to the start of the track you are listening to. Each time you press the button, the track number on the display decreases. The player plays the track with the track number shown on the display.



Track No.

Forward track search

Briefly press the Forward button. Each time you press this button, the track number on the display increases. The player plays the track with the track number shown on the display.



Track No.

CD player features

Direct track search

Function of the KDC-7001

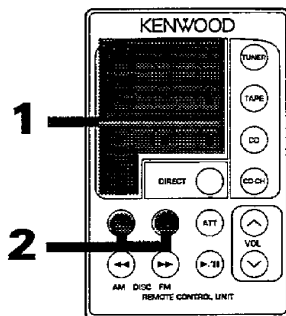

CD player features

1

Enter the number of track you want to listen to.
The input number blinks for 10 seconds and stays lit.

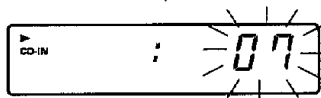

2

Press the **◀◀** or **▶▶** button while the number is blinking.
The player starts playing the track specified in step 1.

To cancel

To cancel search in the middle, press the **▶/||** button.
The Direct track search is cancelled and the normal display returns.

Track repeat

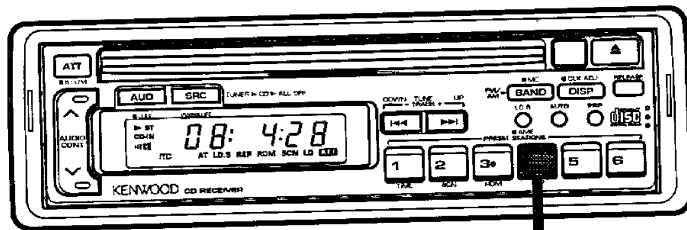

Repeat

To repeat track

Press the Repeat button.
The Repeat indicator will appear on the display and the Track repeat function will turn on.
The same track is played repeatedly.

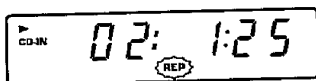

ON

To cancel

Press the Repeat button.
The Repeat indicator disappears and the Track repeat function is cancelled.

CD player features

Track scan

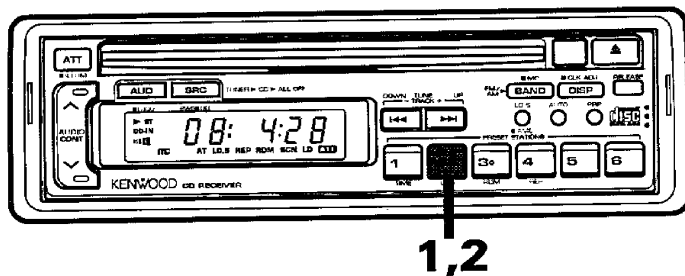

1

Press the Track scan button.
The Track scan indicator will appear on the display and the player will play the first 10 seconds of each track in succession.

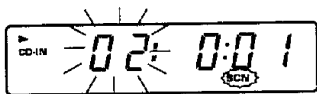

2

To select a track
Press the Track scan button.
The Track scan indicator disappears and the Track scan is cancelled.
Normal playback starts.

NOTE

- When CD play stops, Track scan is cancelled.
- When all tracks on the disc you are listening to are scanned, Track scan is cancelled.

Random play

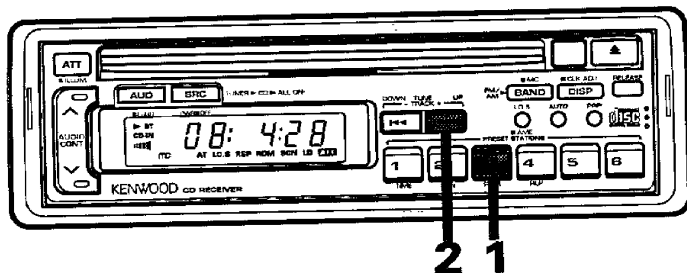

1

Press the Random button. The Random indicator will appear on the display and the player will randomly select another track from the disc you are playing. The track numbers on the display will change continuously during track selection. When a track is selected, playback will begin automatically.

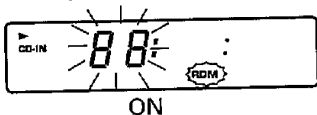

2

To select another track
Press the ►►► button.
The player will randomly choose another track.

To cancel

Press the Random button. The Random indicator disappears and Random play is cancelled. Normal CD play starts.

NOTE

When the CD play stops, the Random play function is cancelled.

CD player features

Audio controls

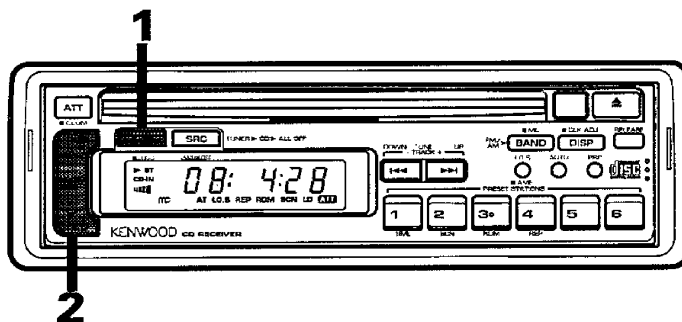

- 1** To select the control mode
Press the Audio button.
Each time you press this button, the adjustment mode changes as follows: Bass -> Treble -> Balance -> Fader -> Volume. If you do not perform the next operation within five seconds, the Volume adjustment mode (normal mode) will return.

NOTE

Source tone memory

This unit allows the Tone (Bass and Treble) control to be set independently for each source mode (FM, AM, and CD). The tone set in CD mode is recalled automatically when you select CD, and the tone set in Tuner mode is recalled automatically when you select Tuner.

- 2** To adjust each mode
Press the Audio control button.
Adjust each mode according to the table.

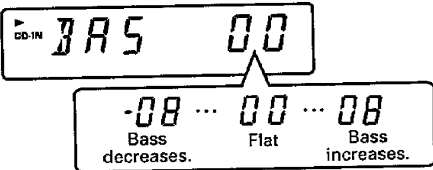
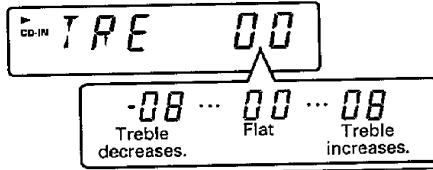
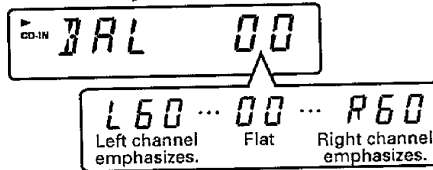
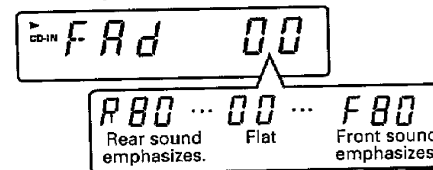
Display	Operation of Audio control button	
	Audio down button	Audio up button
<p><i>Bass adjustment</i></p> 	Bass decreases.	Bass increases.
<p><i>Treble adjustment</i></p> 	Treble decreases.	Treble increases.
<p><i>Balance adjustment</i></p> 	Left channel emphasizes.	Right channel emphasizes.
<p><i>Fader adjustment</i></p> 	Rear sound emphasizes.	Front sound emphasizes.

Other features

Selectable illumination/display type

Illumination

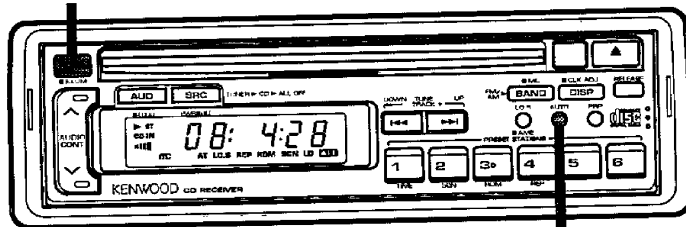

Display type

To change illumination colour

Press the Illumination button for more than one second. Each time you press this button, the illumination will change from green to orange or vice versa.

Function of the KDC-7001/6001 To change the display type

Press the P/N button for more than one second. Each time you press this button, the display type will change from negative to positive or vice versa.

Other features



Negative type

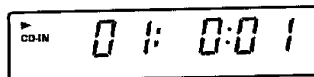

Positive type

Clock display/setting

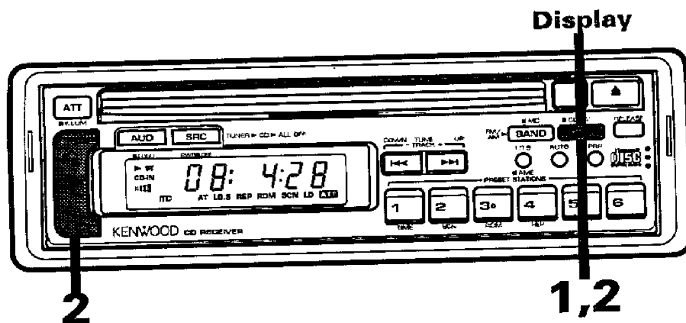

To recall clock display

Press the Display button.
The display changes as listed in the table.

Mode	Displays
Tuner	Frequency ↔ Time
CD	Track number/Track time ↔ Time
All standby	"OFF" ↔ Time

To set the clock

1

If the time is not displayed, press the Display button.
The time is displayed.

2

Hold down the Display button, and press the Audio control button. Press the Audio up button to adjust the hour and the Audio down button to adjust the minutes.

Other features

Theft deterrent faceplate

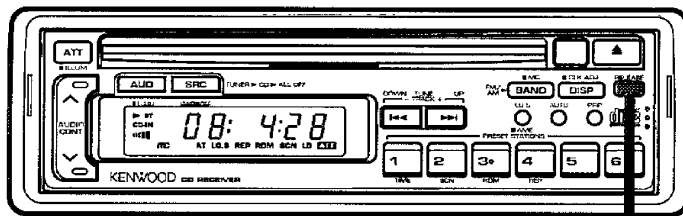

Release

To remove the faceplate

Press the Release button.

The faceplate is unlocked and can be detached.

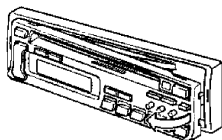

CAUTION

- Place the faceplate in the storage case to prevent shocks. Since it is a precision piece of equipment, if it is subject to shock, it may fail. (KDC-7001; accessory, KDC-6001/5001; optional)

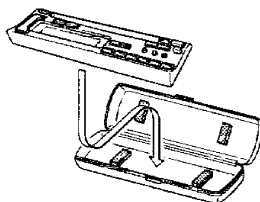

- Do not expose the faceplate or its storage case to direct sunlight or high heat, otherwise it may be deformed or fail.

To install the faceplate

1

Align the projections on the faceplate with the grooves on the faceplate.

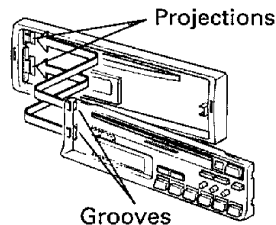

2

Press the faceplate until it clicks. The faceplate is locked in place and the unit becomes operable.

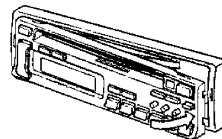

Other features

Disabled system indicator

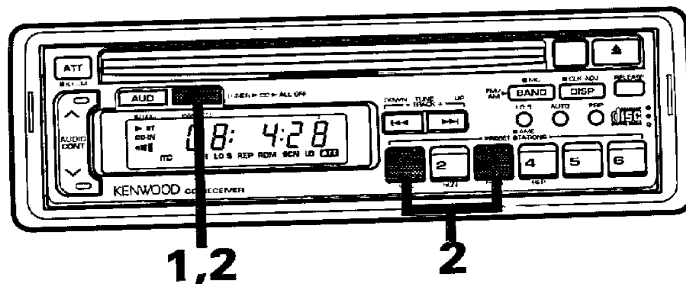

1

Turn the power off.

2





Hold down preset station buttons "1" and "3" and turn the power on. The Disabled system indicator function turns off, and the LED does not blink when the faceplate is detached.

To turn the Disabled system indicator on

Perform steps 1 and 2 again. The LED blinks when the faceplate is detached.

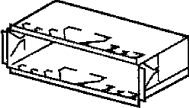
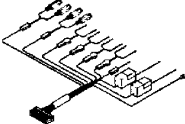
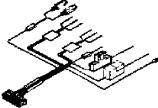
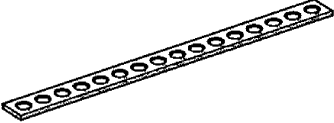
Accessories

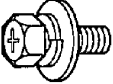
Installation

Part name	External view	Number of items
Mounting sleeve		1
Wiring harness (KDC-7001/6001)		1
Wiring harness (KDC-5001)		1
Metal mounting strap		1
Removal tool		2
Screw with washer (M4 x 8)		1
Machine screw (M5 x 6)		4

Installation procedure

1. Remove the ignition key and disconnect the negative (-) terminal of the battery to prevent short circuits.
2. Connect the input and output cables of the units.
3. Connect the speaker cables of the wiring harness.
4. Connect the ground cable, memory backup cable, and power supply cable of the wiring harness in the order listed.
5. Connect the wiring harness connectors to the unit.
6. Install the unit in the car.
7. Connect the negative (-) terminal of the battery.
8. Press the Reset button.

▲CAUTION

- If the fuse blows, check cables for shorts, then replace the fuse with one of the same rating.
- Check that no unconnected cables or connectors are touching the car body. Do not remove caps from unconnected cables or connectors to prevent short circuits.
- Connect the speaker cables to appropriate speaker connectors separately. Sharing the negative cable of the speaker or grounding speaker cables to the metal body of the car can cause this unit to fail.
- After installation, check that the brake lamps, wipers, and wipers work properly.
- Insulate unconnected ends of cords with vinyl tape or similar.
- This unit must be installed at an angle of less than 30° from the horizontal.

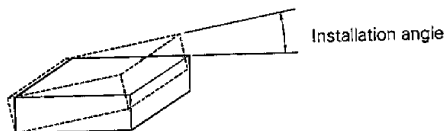

Connections (KDC-7001/6001)

Installation

* Circled numbers indicate the procedures described in the Installation Procedure.

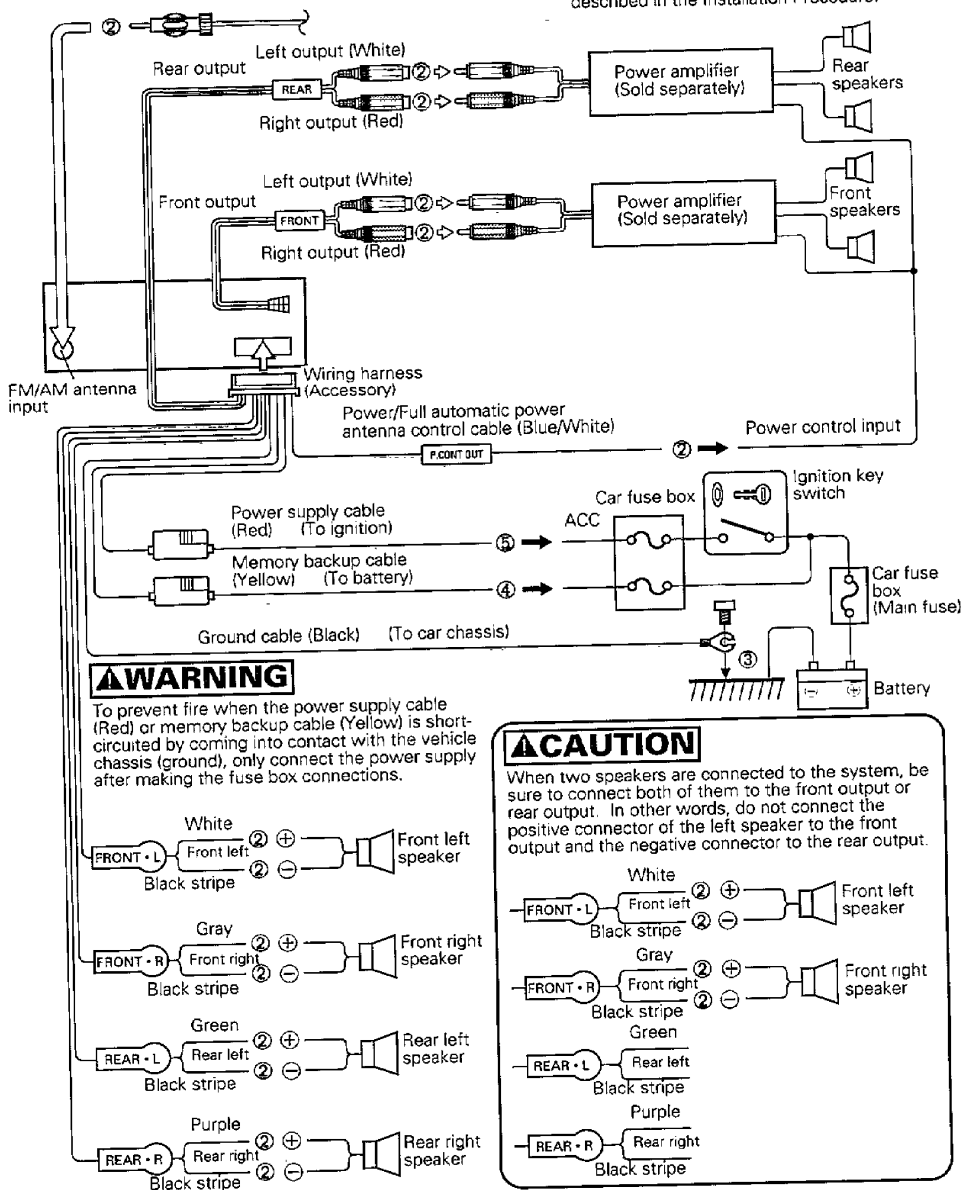

Connections (KDC-5001)

Installation

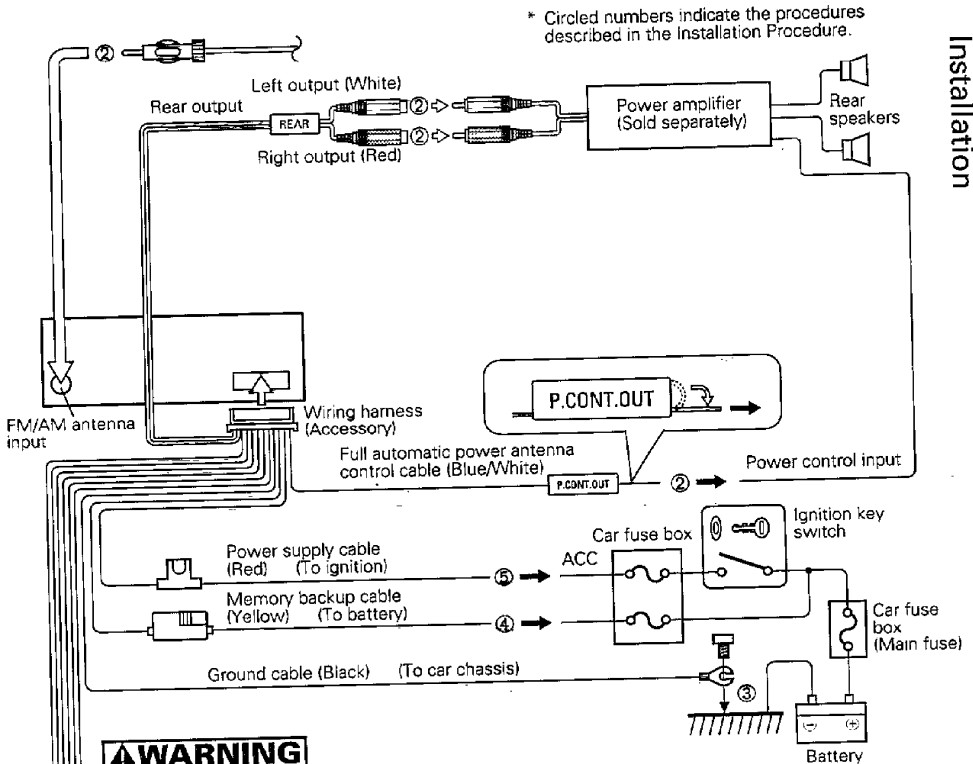

⚠ WARNING

To prevent fire when the power supply cable (Red) or memory backup cable (Yellow) is short-circuited by coming into contact with the vehicle chassis (ground), only connect the power supply after making the fuse box connections.

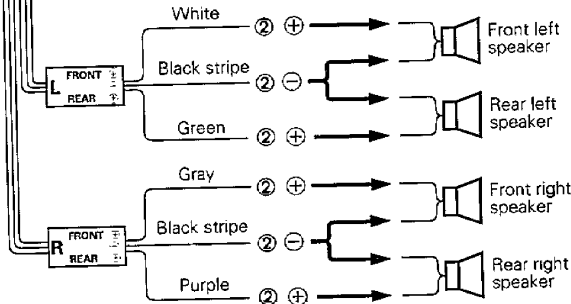

Installation

Installation

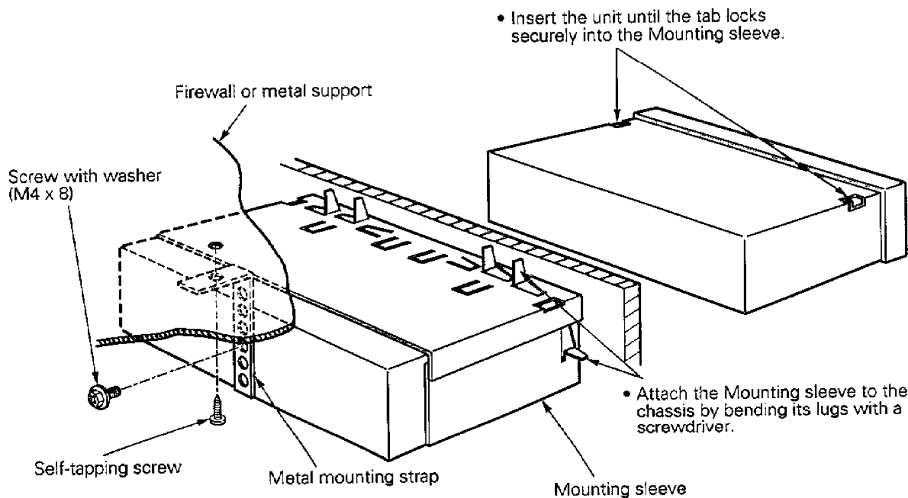

NOTE

Install the unit securely. If the unit is unstable, it may malfunction, causing sound skipping.

To install in the Japanese car

When installing in some cars made in Japan, drive Machine screws (M5 x 6) (accessories) into the two holes corresponding to the car bracket.

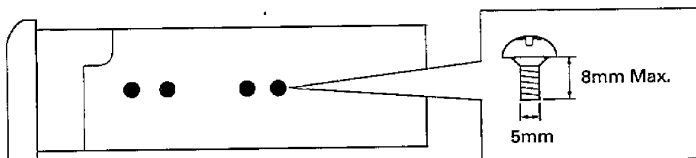

To remove the unit.

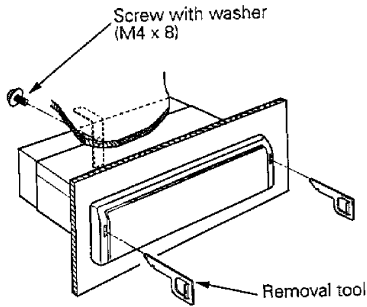

1. Remove the Screws with washer (M4 x 8) holding on the back panel.

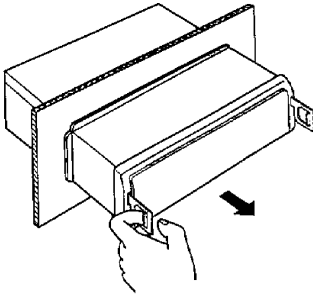

2. Insert the Removal tool into the slot in the unit and pull out the unit. The lock is released and the unit is detached.

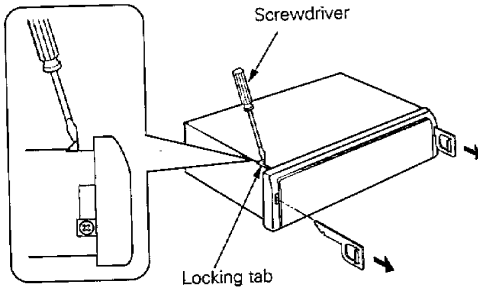

3. Pull out the Removal tool by pressing down the locking tabs on the top using a screwdriver.

Troubleshooting guide

Often, what appears to be a malfunction is due to user error. Before calling for service please consult the following table.

Troubleshooting guide

Symptom	Cause	Remedy
The power is not turned on.	The wiring harness fuse blows.	Check cables for shorts, then replace the fuse with one of with the same rating (shown on the case).
No sound or sound is low.	The volume level is minimum.	Raise the volume level.
	The fader or balance is set to one side.	Adjust the fader and balance.
	The input/output cable or wiring harness is connected incorrectly.	Connect the input/output cable or wiring harness correctly. See "Connections" (Page 36/37).
The unit does not work properly when a button is pressed.	The microcomputer malfunctions.	Press the Reset button on the front panel.
Sound quality is poor. (Sound distortion)	The volume level is too high.	Use the appropriate volume level.
	A speaker cable is pressed by a screw in the car.	Check the speaker cabling.
	A speaker cable is shared.	Connect the speaker output connectors to the separate speaker connectors.
Poor radio reception.	The car antenna is not extended.	Extend the antenna.
	The antenna control cable is not connected.	Connect the cable correctly. See "Connections (Page 36/37)".
When the ignition key switch is set to OFF, the memory contents disappear.	The Memory backup cable is not connected correctly.	Connect the cable correctly. See "Connections (Page 36/37)".
A Disc cannot be inserted.	Another disc has already been inserted.	Eject the previous disc before inserting another.
A disc is ejected immediately after being inserted.	The disc is upside down.	Insert the disc with the title side up.
	The disc is very dirty.	Check and, if possible, clean the disc See "Cleaning your discs" (Page 6).
As disc plays, you hear skipping.	The disc is dirty or damaged.	Check and, if possible, clean the disc See "Cleaning your discs" (Page 6).
Sound quality is poor.	The recording of the disc is poor.	Try playing another disc. If the sound is good, the fault was with the original disc.
	The disc is dirty or damaged.	Check and, if possible, clean the disc See "Cleaning your discs" (Page 6).
The specified track is not played.	The player is set to RANDOM PLAY.	Turn off RANDOM PLAY.

Specifications

Specifications subject to change without notice.

Disc Section	
Laser Diode.....	GaAlAs ($\lambda=780$ nm)
Digital Filter (D/A).....	8 Times Over Sampling
D/A Converter.....	1 bit
Spindle Speed.....	500 ~ 200 rpm (CLV)
Wow & Flutter.....	Below Measurable Limit
Frequency Response.....	10 Hz ~ 20 kHz (± 1 dB)
Total Harmonic Distortion.....	0.01 % (1 kHz)
Signal to Noise Ratio.....	93 dB
Dynamic Range.....	96 dB
Channel Separation.....	85 dB
Laser Diode Properties	
Material.....	GaAlAs
Wavelength.....	780 nm
Emission Duration.....	Continuous
Laser Output Power.....	Less than 44.6 μ W

*This output is the value measured at a distance of 200 mm from the objective lens surface on the Optical Pick-up Block.

FM tuner section	
Frequency Range(200 kHz Space).....	87.9 MHz ~ 107.9 MHz
(50 kHz Space).....	87.5 MHz ~ 108.0 MHz
Usable Sensitivity(S/N = 30 dB).....	9.3 dBf (0.8 μ V/75 Ω)
50 dB Quieting Sensitivity.....	15.2 dBf (1.6 μ V/75 Ω)
Frequency Response.....	30 Hz ~ 15 kHz (± 3 dB)
Signal to Noise Ratio.....	73 dB
Selectivity.....	100 dB
Capture Ratio.....	1.5 dB
Image Response Ratio.....	70 dB
IF Response Ratio.....	120 dB
Stereo Separation.....	40 dB (1 kHz)

AM tuner section	
Frequency Range(10 kHz Space).....	530 kHz ~ 1700 kHz
(9 kHz Space).....	531 kHz ~ 1611 kHz
Usable Sensitivity.....	28 dB (30 μ V)

Audio section	
KDC-5001	
Maximum Power Output.....	8 W \times 4
Power Output(4 Ω , 1 kHz 10% THD).....	6 W \times 4
KDC-6001 /KDC-7001	
Maximum Power Output.....	25 W \times 4
Power Output(4 Ω , 1 kHz 10% THD).....	20 W \times 4
(4 Ω , 30 Hz~20 kHz 1% THD).....	15 W \times 4
Tone Action.....	Bass: ± 8 dB (100 Hz)
	Treble: ± 8 dB (10 kHz)
Preout Level.....	1000 mV / 10 k Ω

General	
Operating Voltage.....	14.4 V (11 ~ 16 V)
Current consumption.....	5.0 A
Operating Temperature.....	-10 ~ 50 $^{\circ}$ C
Installation size (W \times H \times D).....	182 \times 52 \times 163 mm
	(7-3/16 \times 2-1/16 \times 6-7/16 in.)

KDC-5001	
Weight.....	1.5 kg (3.2 lb)
KDC-6001 /KDC-7001	
Weight.....	1.6 kg (3.4 lb)

KENWOOD